

**PATIENT INFORMATION**  
**Sildenafil for Oral Suspension**  
**(sil den' a fil)**

Read this Patient Information before you start taking sildenafil for oral suspension and each time you get a refill. There may be new information. This information does not take the place of talking with your doctor about your medical condition or treatment. If you have any questions about sildenafil for oral suspension, ask your doctor or pharmacist.

**What is the most important information I should know about sildenafil for oral suspension?**

**Never take sildenafil for oral suspension with any nitrate or guanylate cyclase stimulator medicines. Your blood pressure could drop quickly to an unsafe level.**

**Nitrate medicines include:**

- Medicines that treat chest pain (angina)
- Nitroglycerin in any form including tablets, patches, sprays, and ointments
- Isosorbide mononitrate or dinitrate
- Street drugs called "poppers" (amyl nitrate or nitrite)

**Guanylate cyclase stimulators include:**

- Riociguat (Adempas)

Ask your doctor or pharmacist if you are not sure if you are taking a nitrate or a guanylate cyclase stimulator medicine.

**What is sildenafil for oral suspension?**

Sildenafil for oral suspension is a prescription medicine used in adults to treat pulmonary arterial hypertension (PAH). With PAH, the blood pressure in your lungs is too high. Your heart has to work hard to pump blood into your lungs. Sildenafil for oral suspension improves the ability to exercise and can slow down worsening changes in your physical condition.

- Sildenafil for oral suspension is not for use in children
- Adding sildenafil for oral suspension to another medication used to treat PAH, bosentan (Tracleer®), does not result in improvement in your ability to exercise.

Sildenafil for oral suspension contains the same medicine as VIAGRA® (sildenafil), which is used to treat erectile dysfunction (impotence). Do not take sildenafil for oral suspension with VIAGRA or other PDE-5 inhibitors.

**Who should not take sildenafil for oral suspension?**

Do not take sildenafil for oral suspension if you:

- take nitrate medicines. See "What is the most important information I should know about sildenafil for oral suspension?"
- take guanylate cyclase stimulator medicines. See "What is the most important information I should know about sildenafil for oral suspension?"
- are allergic to sildenafil or any other ingredient in sildenafil for oral suspension. See "What are the ingredients in sildenafil for oral suspension?" at the end of this leaflet.

**What should I tell my doctor before taking sildenafil for oral suspension?**

Tell your doctor about all of your medical conditions, including if you

- have heart problems such as angina (chest pain), heart failure, irregular heartbeats, or have had a heart attack
- have a disease called pulmonary veno-occlusive disease (PVOD)
- have high or low blood pressure or blood circulation problems
- have an eye problem called retinitis pigmentosa
- have or had loss of sight in one or both eyes
- have any problem with the shape of your penis or Peyronie's disease
- have any blood cell problems such as sickle cell anemia
- have a stomach ulcer or any bleeding problems
- are pregnant or planning to become pregnant. It is not known if sildenafil for oral suspension could harm your unborn baby.
- are breastfeeding. Sildenafil passes into your breast milk, it is not known if it could harm your baby.

**Tell your doctor about all of the medicines you take, including prescription and non-prescription medicines, vitamins, and herbal products.** Sildenafil for oral suspension and certain other medicines can cause side effects if you take them together. The doses of some of your medicines may need to be adjusted while you take sildenafil for oral suspension.

**Especially tell your doctor if you take**

- Nitrate medicines. See "What is the most important information I should know about sildenafil for oral suspension?"
- Riociguat (Adempas). See "What is the most important information I should know about sildenafil for oral suspension?"
- Ritonavir (Norvir®) or other medicines used to treat HIV infection
- Ketoconazole (Nizoral®)
- Itraconazole (Sporanox)
- High blood pressure medicine

Know the medicines you take. Keep a list of your medicines and show it to your doctor and pharmacist when you get a new medicine.

**How should I take sildenafil for oral suspension?**

- Take sildenafil for oral suspension exactly as your doctor tells you.

Sildenafil may be prescribed to you as

- Sildenafil tablets or sildenafil oral suspension
- Take sildenafil tablet or oral suspension 3 times a day about 4 to 6 hours apart
- Take sildenafil tablets or oral suspension at the same times every day.
- Sildenafil oral suspension will be mixed for you by your pharmacist. Do not mix sildenafil oral suspension with other medicine or flavoring. Shake well for at least 10 seconds before each dose.
- If you miss a dose, take it as soon as you remember. If it is close to your next dose, skip the missed dose, and take your next dose at the regular time.

- Do not take more than one dose of sildenafil for oral suspension at a time.
- Do not change your dose or stop taking sildenafil for oral suspension on your own. Talk to your doctor first.
- **If you take too much sildenafil, call your doctor or go to the nearest hospital emergency room.**

**What are the possible side effects of sildenafil for oral suspension?**

- **low blood pressure.** Low blood pressure may cause you to feel faint or dizzy. Lie down if you feel faint or dizzy.
- **more shortness of breath than usual.** Tell your doctor if you get more short of breath after you start sildenafil for oral suspension. More shortness of breath than usual may be due to your underlying medical condition.
- **decreased eyesight or loss of sight in one or both eyes (NAION).** If you notice a sudden decrease or loss of eyesight, talk to your doctor right away.
- **sudden decrease or loss of hearing.** If you notice a sudden decrease or loss of hearing, talk to your doctor right away. It is not possible to determine whether these events are related directly to this class of oral medicines, including sildenafil for oral suspension, or to other diseases or medicines, to other factors, or to a combination of factors.
- **heart attack, stroke, irregular heartbeats, and death.** Most of these happened in men who already had heart problems.
- **erections that last several hours.** If you have an erection that lasts more than 4 hours, get medical help right away. If it is not treated right away, priapism can permanently damage your penis.

**The most common side effects with sildenafil for oral suspension include:**

Nosebleed, headache, upset stomach, getting red or hot in the face (flushing), trouble sleeping, as well as fever, erection increased, respiratory infection, nausea, vomiting, bronchitis, pharyngitis, runny nose, and pneumonia in children.

**Tell your doctor if you have any side effect that bothers you or doesn't go away.**

*These are not all the possible side effects of sildenafil for oral suspension. For more information, ask your doctor or pharmacist.*

Call your doctor for medical advice about side effects. You may report side effects to FDA at 1-800-FDA-1088.

**How should I store sildenafil for oral suspension?**

- Store sildenafil reconstituted oral suspension below 30°C (86°F) or in a refrigerator between 2° to 8°C (36° to 46°F).
- Do not freeze sildenafil oral suspension.
- Throw away sildenafil oral suspension after 60 days.
- **Keep sildenafil for oral suspension and all medicines away from children.**

**General information about sildenafil for oral suspension**

Medicines are sometimes prescribed for purposes that are not in the patient leaflet. Do not use sildenafil for oral suspension for a condition for which it was not prescribed. Do not give sildenafil for oral suspension to other people, even if they have the same symptoms you have. It could harm them.

This patient leaflet summarizes the most important information about sildenafil for oral suspension. If you would like more information about sildenafil for oral suspension talk with your doctor. You can ask your doctor or pharmacist for information about sildenafil for oral suspension that is written for health professionals. For more information call Aurobindo Pharma USA, Inc. at 1-866-850-2876.

**What are the ingredients in sildenafil for oral suspension?**

**Active ingredient:** sildenafil citrate

**Inactive ingredients:** citric acid anhydrous, colloidal silicon dioxide, grape flavor, maize maltodextrin, sodium benzoate, sodium citrate (dihydrate), sorbitol, sucralose, titanium dioxide and xanthan gum.

This Patient Information has been approved by the U.S. Food and Drug Administration.

The brands listed are trademarks of their respective owners and are not trademarks of Aurobindo Pharma Limited.

**Dispense with Patient Information available at: [www.aurobindousa.com/medication-guides](http://www.aurobindousa.com/medication-guides).**

Distributed by:

**Aurobindo Pharma USA, Inc.**  
279 Princeton-Hightstown Road  
East Windsor, NJ 08520

Manufactured by:



**Aurobindo Pharma Limited**  
Hyderabad-500 032, India

Revised: November 2022

**Instructions for Use**  
**Sildenafil Oral Suspension**  
**(sil den' a fil)**

Read this Instructions for Use for sildenafil oral suspension before you start taking and each time you get a refill. There may be new information. This information does not take the place of talking to your doctor about your medical condition or your treatment.

A/s: 230 x 380 mm ■ Black

	<b>Product Name</b>	<b>Component</b>	<b>Item Code</b>	<b>Date &amp; Time</b>
	Sildenafil for Oral Suspension	PIS	P1532385	09.11.2022 & 10.00 am
<b>Team Leader:</b> Jagan <b>Initiator:</b> Sindoor	<b>Customer / Country</b>	<b>Version No.</b>	<b>Reason of Issue</b>	<b>No. of Colours : 01</b>
	USA_APL	00	Submission	
<b>Design Agency</b> 	<b>Dimensions</b>			
	230 x 380 mm			
<b>Date - Designer Name - Ver No:</b>				
1. Umesh (00) 09.11.2022		3.		
2.		4.		
5.		6.		
<b>Additional Information:</b>				
Supersede Code : P1523491				

**Important information:**

- Your pharmacist should tell you how to measure sildenafil oral suspension by using the oral syringe provided in the pack.
- Sildenafil oral suspension should only be given using the oral syringe supplied with each pack.
- Sildenafil for oral suspension should not be mixed with any other medicine or flavoring.

**Supplies you will need to take sildenafil oral suspension:**

- Bottle of sildenafil oral suspension with syringe adaptor fitted in neck of bottle
- Oral syringe (as supplied by pharmacist). (See Figure A)

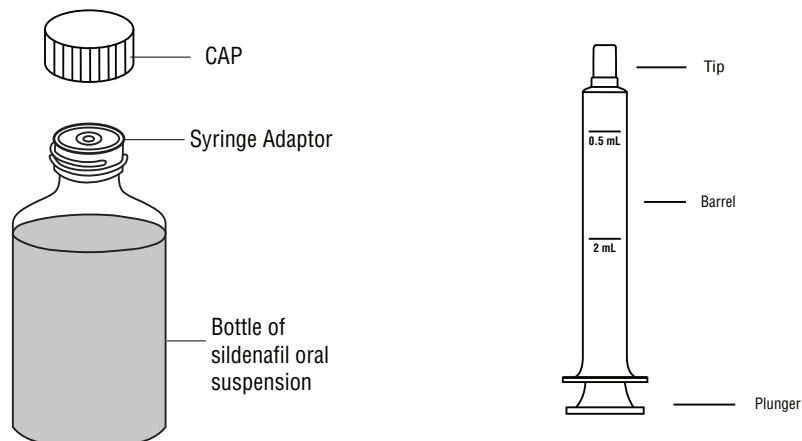

Figure A

1. Shake the bottle of sildenafil oral suspension for 10 seconds before each use. (See Figure B)
2. Remove the cap. Open the bottle by pushing downward on the cap and twisting it in the direction of the arrow (counter-clockwise). (See Figure B)

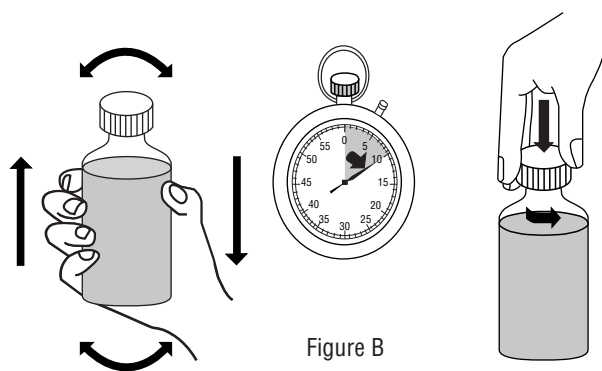

Figure B

3. Insert the tip of the oral syringe into the adaptor while the bottle is upright, on a flat surface. Fully push down (depress) the plunger of the syringe. (See Figure C)

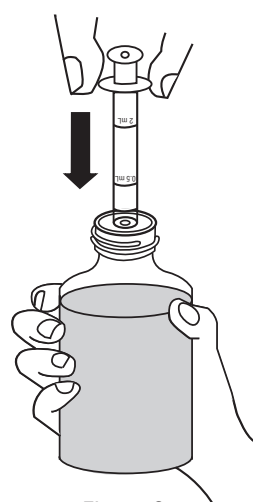

Figure C

4. Turn the bottle upside down while holding the oral syringe in place. Slowly pull back the plunger of the oral syringe until the bottom of the plunger is even with the graduation markings on the syringe for the prescribed dose for you. Take your dose of sildenafil oral suspension exactly as prescribed by your doctor. If air bubbles can be seen, slowly push the oral suspension in the syringe back into the bottle. Repeat steps 3 and 4. (See Figure D)

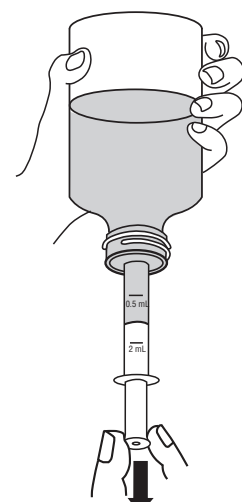

Figure D

5. Turn the bottle back upright with the oral syringe still in place. Remove the oral syringe from the bottle by pulling straight up on the barrel of the oral dosing syringe. (See Figure E)

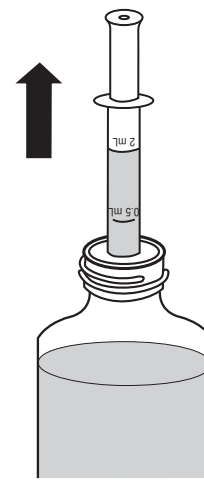

Figure E

6. Put the tip of the oral syringe into your mouth. Point the tip of the oral syringe towards the inside of the cheek. Slowly push down the plunger of the oral syringe. (See Figure F)

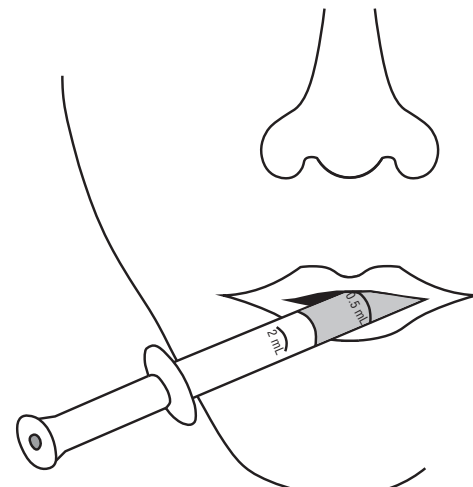

Figure F

7. Replace the cap on the bottle, leaving the bottle adaptor in place. Wash the oral syringe as instructed below.
8. The syringe should be washed after each dose. Pull the plunger out of the barrel and rinse both parts with water. (See Figure G)

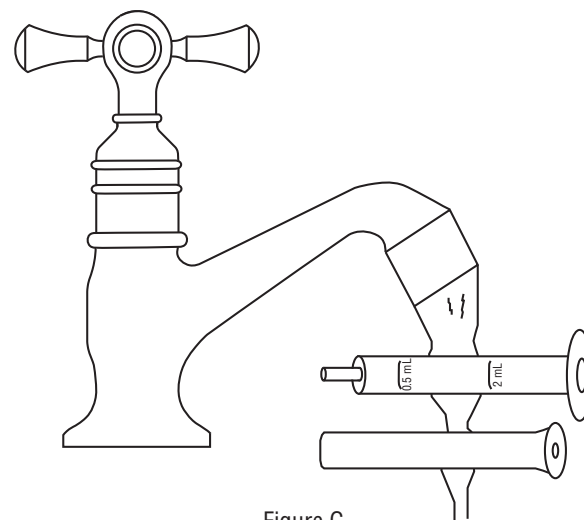

Figure G

9. Dry all parts with a clean paper towel. Push the plunger back into the barrel. Store the syringe with sildenafil oral suspension in a clean safe place.

Administer sildenafil oral suspension using the oral syringe supplied with each pack. Refer to the patient instructions for use for more detailed instructions for use. Discard any unused suspension after the expiration date written on the bottle.

**How should I store sildenafil oral suspension?**

- Store sildenafil reconstituted oral suspension below 30°C (86°F) or in a refrigerator between 2° to 8°C (36° to 46°F).
- Do not freeze sildenafil oral suspension
- Throw away (discard) sildenafil oral suspension after 60 days.
- **Keep sildenafil for oral suspension and all medicines away from children.**

This Instruction for Use has been approved by the U.S. Food and Drug Administration.

Distributed by:

**Aurobindo Pharma USA, Inc.**  
279 Princeton-Hightstown Road  
East Windsor, NJ 08520

Manufactured by:

**Aurobindo Pharma Limited**  
Hyderabad-500 032, India

Revised: November 2022